

YOUR TRUCK SHOULD LOOK LIKE THIS

FITS 1 AND 2 PC WINDSHIELD WITH FACTORY INSTALLED
3 PIECE VISOR WITH 3 BRACKETS
AND CAST STYLE MIRRORS

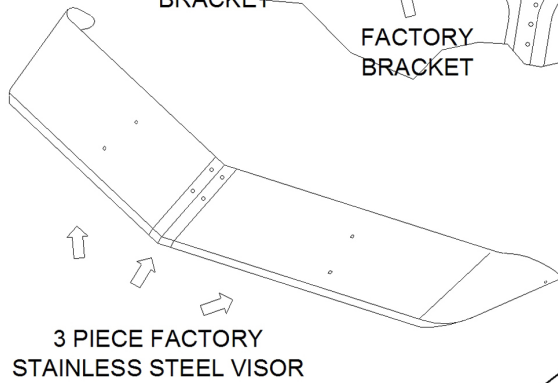

DOES NOT FIT
1 AND 2 PC WINDSHIELD
WITH FACTORY INSTALLED
1 PIECE VISOR WITH 2 BRACKETS

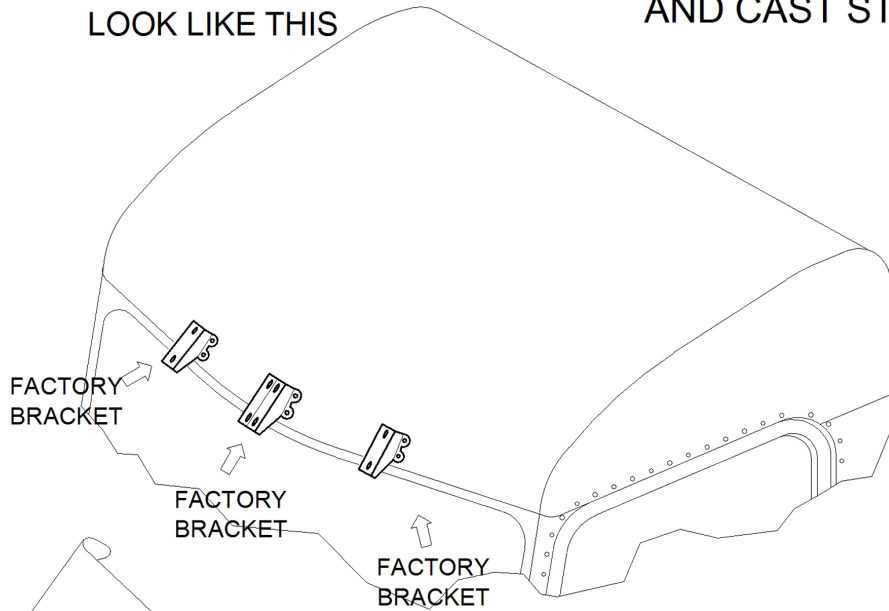
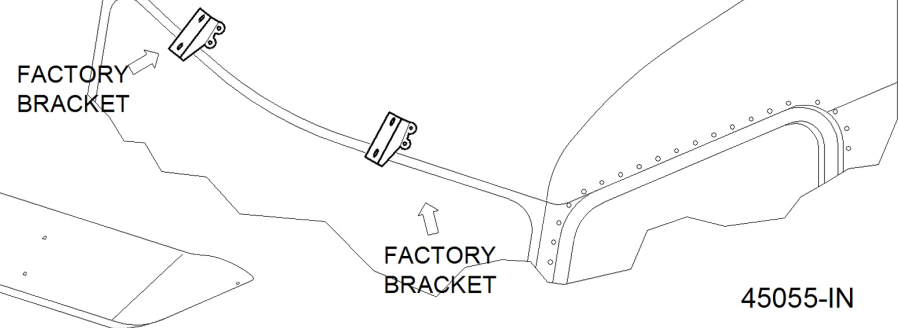

13" DROP VISOR FOR 1 & 2 PIECE CURVED WINDSHIELD KENWORTH 2006 & EARLIER WITH CAST STYLE MIRRORS. REPLACES FACTORY 3 PIECE STAINLESS STEEL VISOR WITH 3 BRACKETS. DOES NOT FIT TRUCKS WITH FACTORY FIBERGLASS VISOR OR STAINLESS TUBULAR MIRRORS.

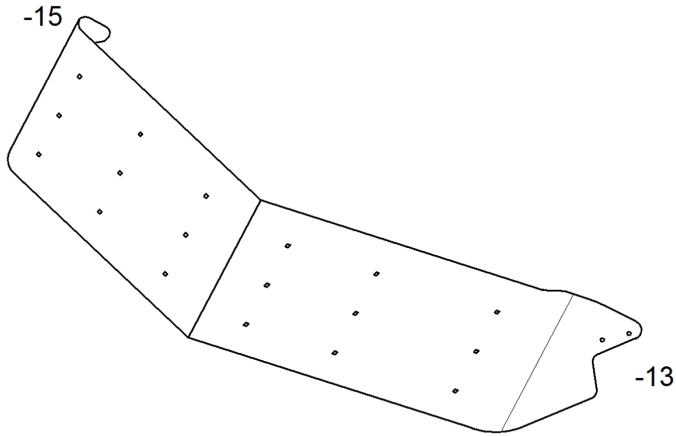

SIDE VIEW OF STABILIZER
(RESTS ON WINDSHIELD)

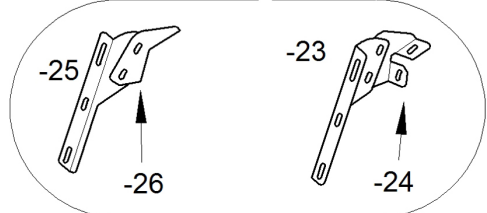
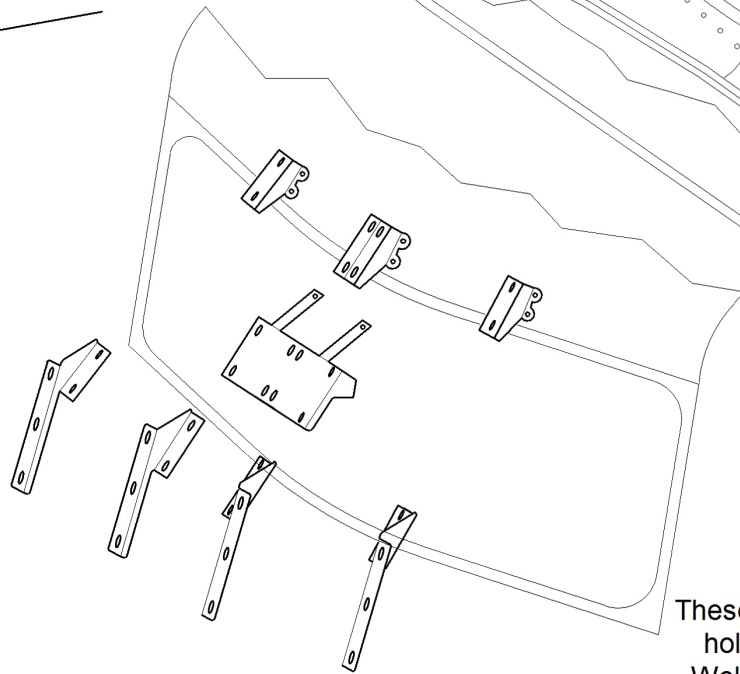
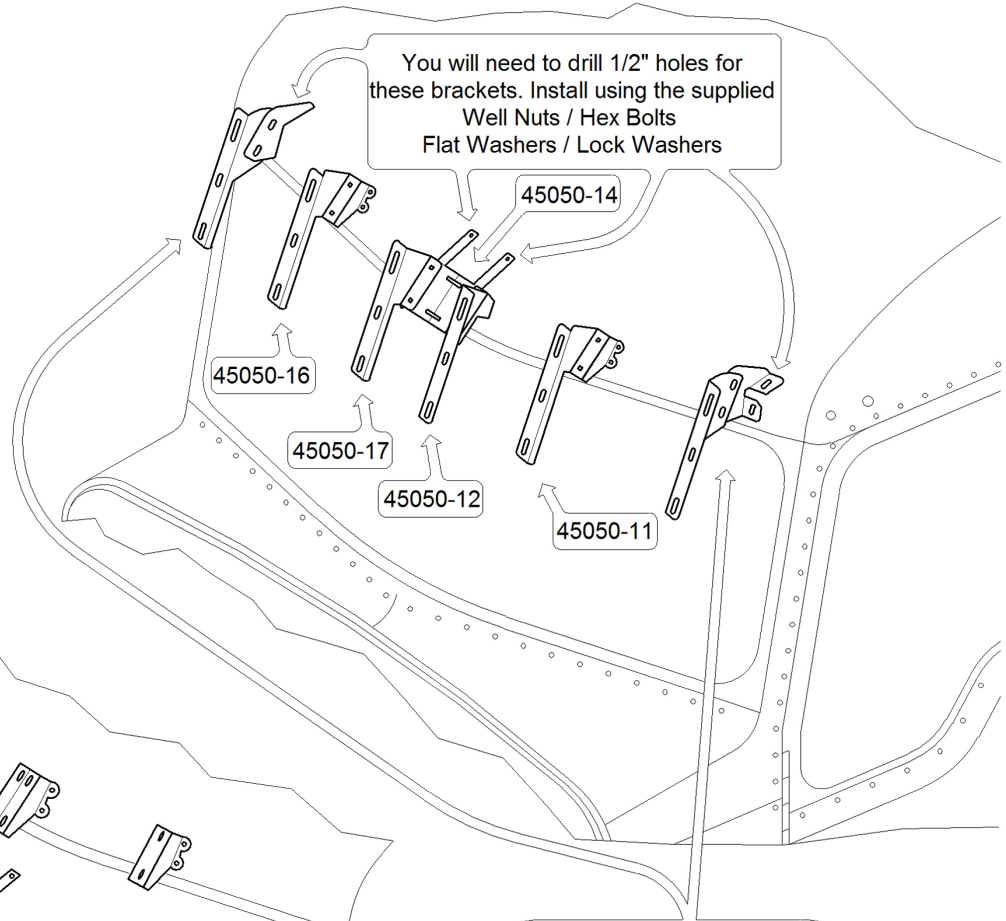
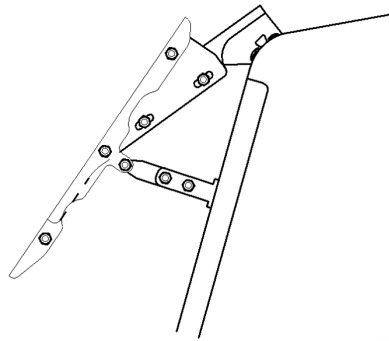

These are additional brackets. You will need to drill 1/2\" holes for these brackets. Install using the supplied Well Nuts / Hex Bolts / Flat Washers / Lock Washers